

D93014

| | |
|----------|--|
| PROJECT | |
| TYPE | |
| NOTES | |
| QUANTITY | |
| DATE | |

GENERAL

Series: Finestra
 Brand: Milan
 Division: Design
 Mounting Type: Surface
 Mounting Location: Wall
 Subcategory: Ambient

PHYSICAL

Shape: Rectangle
 Length (mm): 620
 Length (in): 24 7/16
 Height (mm): 145
 Height (in): 5 11/16
 Extension (mm): 45
 Extension (in): 1 3/4
 Light Distribution: Direct / Indirect
 Weight (kg): 2.04
 Weight (lbs): 4.5
 Diffuser: White Opal Glass
 Fixture Finish: SST
 Fixture Material: Metal

ELECTRICAL

Number of Lamps: 2
 Lamp Type: T5 Fluorescent
 Bulb Included: Bulb Not Included
 Total Output Wattage (W): 48
 Max. Wattage Per Lamp (W): 24
 Lamp Base: G5 Bi-pin
 Dimming: Non-Dimmable
 Input Voltage (V): 120
 Lamp Voltage (V): 120

LED

OPTICAL

RATINGS AND CERTIFICATIONS

Certified By: CSA Certified to UL and CSA Standards
 IP rating: IP20

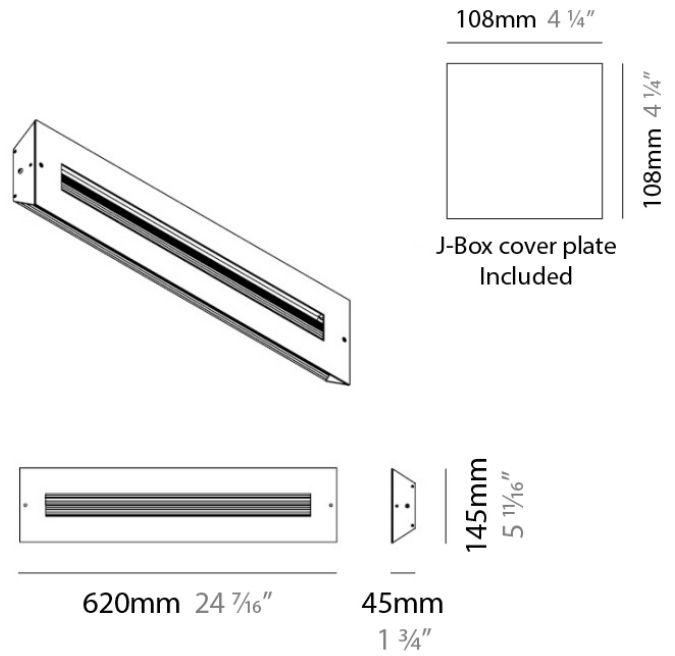

D93019

| |
|----------|
| PROJECT |
| TYPE |
| NOTES |
| QUANTITY |
| DATE |

GENERAL

Series: Finestra
 Brand: Milan
 Division: Design
 Mounting Type: Surface
 Mounting Location: Wall
 Subcategory: Ambient

PHYSICAL

Shape: Rectangle
 Length (mm): 254
 Length (in): 10
 Width (mm): 150
 Width (in): 6
 Height (mm): 145
 Height (in): 5 ¹¹/₁₆
 Extension (mm): 45
 Extension (in): 1 ³/₄
 Weight (kg): 1.23
 Weight (lbs): 2.7
 Fixture Material: Metal

ELECTRICAL

Number of Lamps: 2
 Lamp Type: LED Retrofit / Halogen
 Lamp Shape: T3
 Bulb Included: Bulb Not Included
 Total Output Wattage (W): 28 / 150
 Max. Wattage Per Lamp (W): 28 / 150
 Lamp Base: RSC
 Input Voltage (V): 120

LED

OPTICAL

RATINGS AND CERTIFICATIONS

Certified By: CSA Certified to UL and CSA Standards
 IP rating: IP20

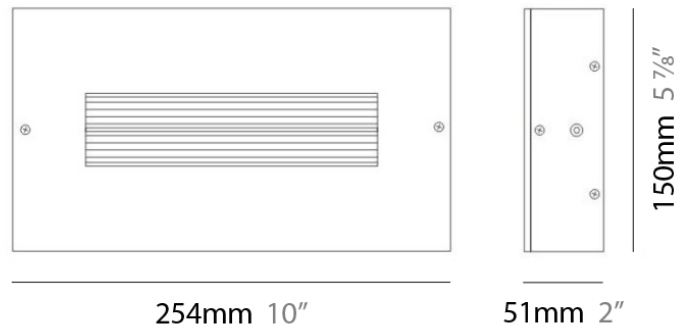

D93154

| | |
|----------|--|
| PROJECT | |
| TYPE | |
| NOTES | |
| QUANTITY | |
| DATE | |

GENERAL

Series: Finestra
 Brand: Milan
 Division: Design
 Mounting Type: Surface
 Mounting Location: Wall
 Subcategory: Ambient

PHYSICAL

Shape: Rectangle
 Length (mm): 620
 Length (in): 24 7/16
 Height (mm): 145
 Height (in): 5 11/16
 Extension (mm): 45
 Extension (in): 1 3/4
 Light Distribution: Direct / Indirect
 Weight (kg): 1.8
 Weight (lbs): 4
 Fixture Finish: WHI
 Fixture Material: Metal

ELECTRICAL

Number of Lamps: 2
 Lamp Type: T5 Fluorescent
 Bulb Included: Bulb Not Included
 Total Output Wattage (W): 48
 Max. Wattage Per Lamp (W): 24
 Lamp Base: G5 Bi-pin
 Dimming: Non-Dimmable
 Input Voltage (V): 120
 Lamp Voltage (V): 120

LED







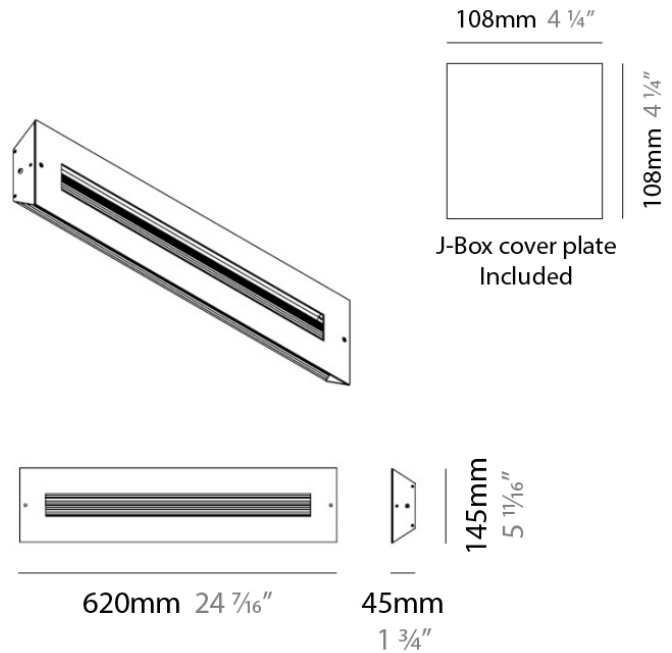





























































OPTICAL

RATINGS AND CERTIFICATIONS











Certified By: CSA Certified to UL and CSA Standards
 IP rating: IP20













LEGEND

| | | | | | |
|--|---|---|--|---|--|
|  | floor-mounted |  | pivotal |  | special LED (upon request) RGB, RGBW, tunable, gold+, meat+, art+, fashion+ |
|  | wall and ceiling: recessed and surface mounted |  | rotating |  | warm dim / natural dimming LED |
|  | ceiling-mounted and wall-mounted |  | illuminate tilted |  | rechargeable battery powered |
|  | wall-mounted |  | color of suspension cable |  | fixture with natural vivid LED (upon request) |
|  | omni-directional light distribution |  | length of suspension cable |  | color rendering index |
|  | direct light distribution |  | reflector degree selection |  | color temperature |
|  | direct/indirect light distribution |  | super spot |  | lumen (luminous flux) |
|  | indirect light distribution |  | lens |  | efficacy (lumens per watt) |
|  | asymmetric light distribution |  | lens pack |  | Unified Glare Rating (UGR) range from 5-40 |
|  | aura light distribution |  | shine ring |  | marine grade (AISI 316 stainless steel) |
|  | round wall or ceiling cut-out |  | integrated shine ring with diffuser |  | walk on |
|  | square wall or ceiling cut-out |  | free individual colors 01-29 |  | drive on |
|  | the supplied jig specifies the cutout dimensions |  | individual colors: 00 (free of charge), 01-25 (extra charge) |  | Dark Sky Compliance |
|  | minimum distance (meters) lamp - object |  | luminaire part to be colored (F1) |  | Americans with Disabilities Act (less than 4" off the wall located between 27"-84" from floor) |
|  | recessed depth |  | luminaire part to be colored (F2) |  | lamp protected against explosion |
|  | ceiling thickness in mm |  | luminaire part to be colored (F3) |  | blown glass using traditional methods by master glass blower |
|  | ceiling thickness selection |  | luminaire part to be colored (F4) |  | acoustic material |
|  | dimmable DP (phase), DV (0-10V), DD (dali), DS (step-dim) |  | luminaire part to be colored (F5) |  | protection class I, protection insulation |
|  | included or excluded LED driver/transformer/control gear |  | color of 3-circuit adaptor |  | protection class II, protection insulation |
|  | separately switchable |  | indirect diffuser |  | ETL Certified to UL and CSA Standards |
|  | sensor |  | direct diffuser |  | UL Certified to UL and CSA Standards |
|  | remote control |  | ball-proof (upon request) |  | CSA Certified to UL and CSA Standards |
|  | available upon request |  | accessory |  | Certified for North American Standards |

IP RATING

| | |
|---|--|
|  | protected against ingress of solid bodies greater than 12.5mm (finger) |
|  | protected against ingress of solid bodies greater than 2.5mm protected against sprays of water up to 60 degrees from the vertical (rain) |
|  | protected against ingress of solid bodies greater than 1mm (wire) no protection against the ingress of moisture |
|  | protected against ingress of solid bodies greater than 1mm (wire) protected against sprays of water up to 60 degrees from the vertical (rain) |
|  | protected against ingress of solid bodies greater than 1mm (wire) protected against water splashed from all directions |
|  | protected against limited ingress of dust (wet rooms/covered outdoor areas) protected against water splashed from all directions |
|  | protected against ingress of dust protected against jets of water |
|  | protected against ingress of dust protected against powerful jets of water or heavy seas |
|  | protected against ingress of dust protected against immersion of water between 15cm - 1m for 30 minutes |
|  | protected against ingress of dust protected against immersion of water under pressure for long periods |

IK RATING

| | |
|---|---|
|  | protected against 0.14 joules impact (equivalent to 0.25kg mass dropped from 56mm above the surface) |
|  | protected against 0.2 joules impact (equivalent to 0.25kg mass dropped from 80mm above the surface) |
|  | protected against 0.35 joules impact (equivalent to 0.25kg mass dropped from 140mm above the surface) |
|  | protected against 0.5 joules impact (equivalent to 0.25kg mass dropped from 200mm above the surface) |
|  | protected against 0.7 joules impact (equivalent to 0.25kg mass dropped from 280mm above the surface) |
|  | protected against 1 joules impact (equivalent to 0.25kg mass dropped from 400mm above the surface) |
|  | protected against 2 joules impact (equivalent to 0.5kg mass dropped from 400mm above the surface) |
|  | protected against 5 joules impact (equivalent to 1.7kg mass dropped from 300mm above the surface) |
|  | protected against 10 joules impact (equivalent to 5.0kg mass dropped from 200mm above the surface) |
|  | protected against 20 joules impact (equivalent to 5.0kg mass dropped from 400mm above the surface) |